

# 44773

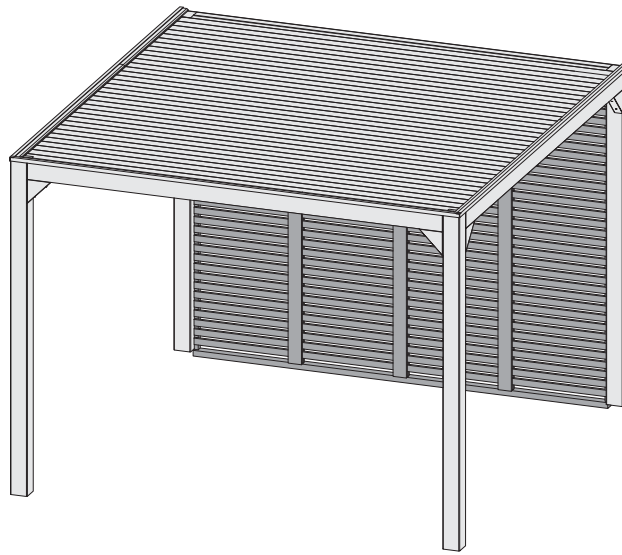

-  **Aufbauanleitung**
-  **Building Instructions**
-  **notice de montage**
-  **montagehandleiding**
-  **Montagevejledning**
-  **Instrucciones de construcción**
-  **Istruzioni per il montaggio**
-  **Montážní návod**



Vergleichen Sie zuerst die Material-liste mit Ihrem Paketinhalt! Bitte haben Sie Verständnis, dass Beanstandungen nur im nicht aufgebauten Zustand bearbeitet werden können!



Vergelijk eerst de lijst van materialen met de inhoud van uw pakket! Reclamaties kunnen alleen in behandeling worden genomen zolang de onderdelen nog niet zijn gemonteerd!



Confrontate questa distinta materiali prima con il contenuto del pacchetto! Vi preghiamo di comprendere che eventuali reclami possono essere accolti solo prima del montaggio!



First compare the list of materials with your package contents! Please understand that complaints can be processed in the non-built status only!



Start med at kontrollere materialelisten med indholdet af den leverede pakke! Vi gør venligst opmærksom på at reklamationer kun kan behandles for materialer som ikke er blevet bearbejdet!



Nejprve přezkontrolujte obsah balení podle materiálového listu! Mějte pochopení pro to, že případnou reklamaci se můžeme zabývat pouze tehdy, když díly nebudou smontované! Za pomoci tohoto seznamu můžete jednotlivé díly přiřadit k montážnímu návodu.



Commencez par comparer la liste du matériel avec le contenu de votre paquet! Sachez que nous traitons uniquement les réclamations concernant le matériel à l'état non monté!



En primer lugar, compare la lista de material con el contenido del paquete. Rogamos entienda que las reclamaciones sólo pueden ser tramitadas antes de montar el objeto!

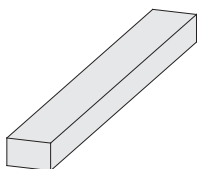
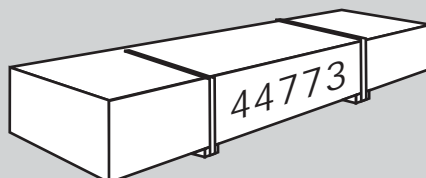

|         |        |      |       |          |
|---------|--------|------|-------|----------|
| 33 x E1 | 2950 x | 18 x | 45 mm | ID 56502 |
| 6 x E2  | 2200 x | 18 x | 95 mm | ID 52334 |

|        |        |      |       |          |
|--------|--------|------|-------|----------|
| 2 x E3 | 2230 x | 28 x | 38 mm | ID 59429 |
| 1 x E4 | 2960 x | 40 x | 60 mm | ID 15809 |

|       |          |         |
|-------|----------|---------|
|       |          |         |
| 126 x | 4 x 35mm | ID 3687 |
| 15 x  | 4 x 50mm | ID 3688 |

01

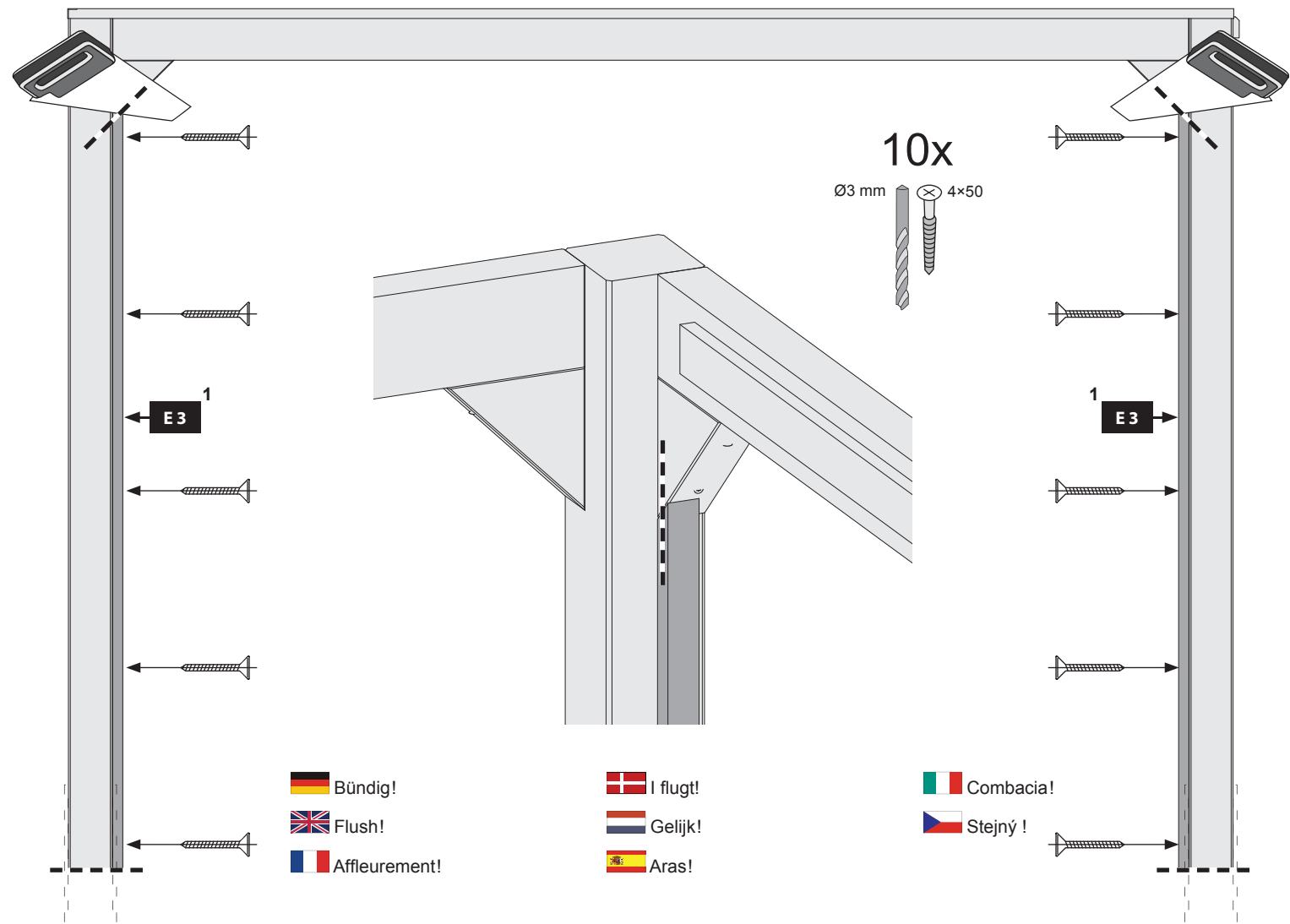

Bündig!  
 Flush!  
 Affleurement!

I flugt!  
 Gelijk!  
 Aras!

Combacia!  
 Stejný!

02

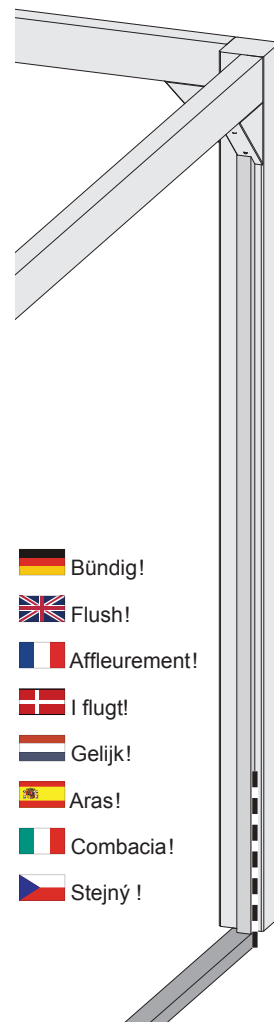
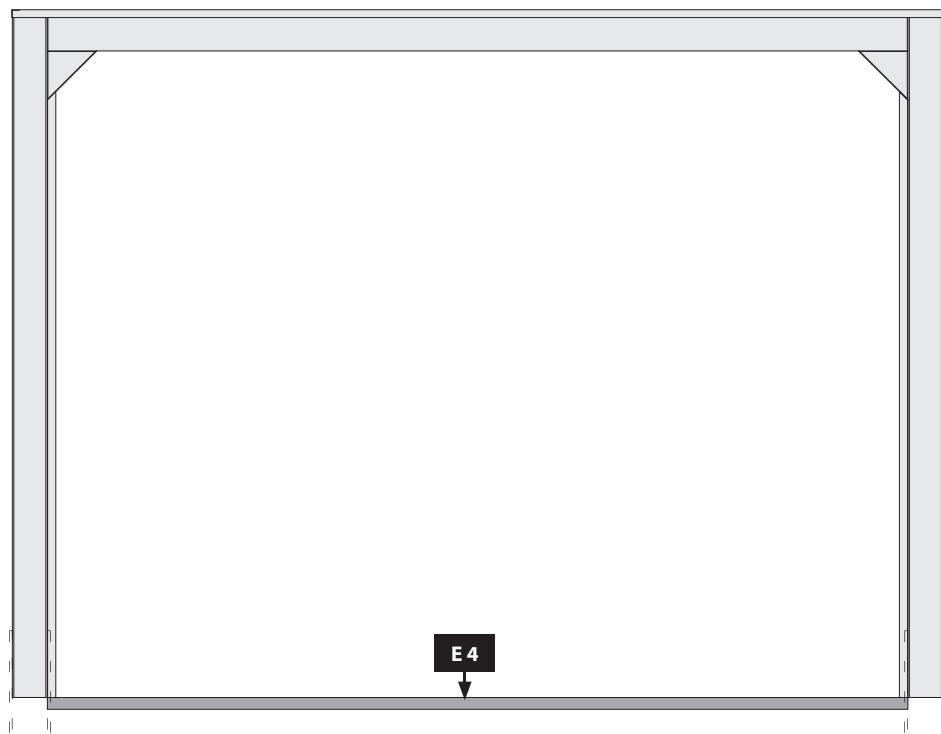

-  Bündig!
-  Flush!
-  Affleurement!
-  I flugt!
-  Gelijk!
-  Aras!
-  Combacia!
-  Stejný !

03

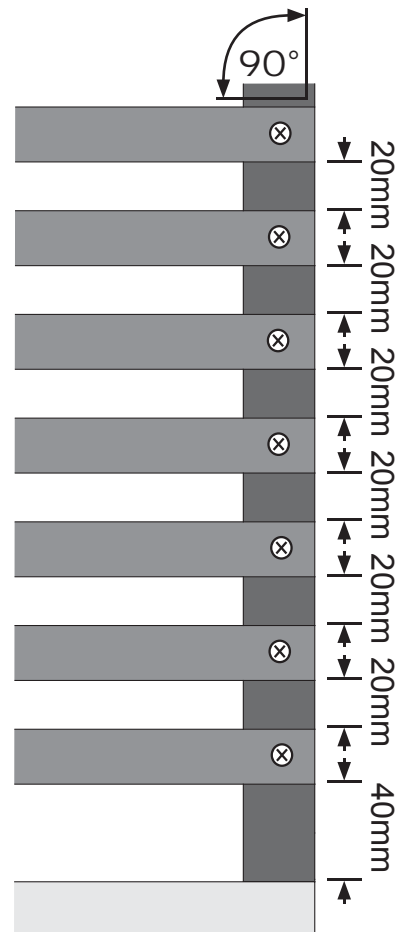
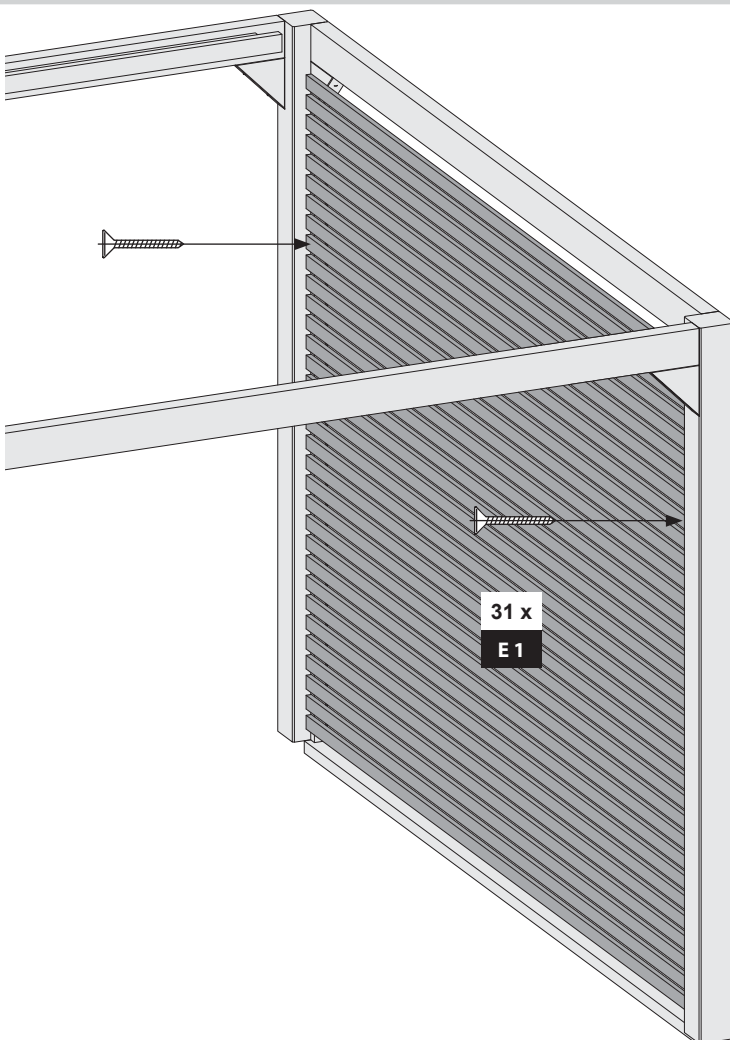

66x

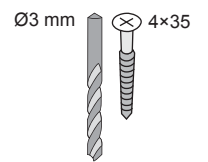

30x

Ø3 mm 4x35

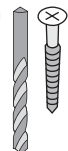

-  außen
-  outside
-  à l'extérieur
-  buiten
-  udenfor
-  fuera
-  al di fuori
-  vně

30x

Ø3 mm 4x35

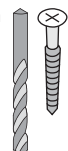

-  innen
-  Inside
-  à l'intérieur
-  binnen
-  inde
-  dentro
-  dentro
-  uvnitř

